

# Dillon RL 550B

## Instruction Manual

May 2007



**Dillon**  
**Precision**

Products, Inc.

Manufacturers of  
The World's Finest  
Loading Equipment

# RL 550B Parts List

Part #	Description	Part #	Description
13149	Manual	* 13930	Locator Buttons (3)
13409	Crank	13939	Body Collar Clamp
13573	Machine Box	13940	Body Collar - Part
13583	Link Arm, Left	13943	Powder Bar Bolt
13644	Powder Bar Spacer	13951	Powder Bar Post, Small
13650	Spent Primer Cup	13957	Magazine Shield Cap
13673	Primer Magazine, Red, Large	13958	Powder Bar Bolt Washer
13691	Powder Measure Tube	13961	Slide Pickup Adjustment Screw
13700	Link Arm Pin	13964	Retain Spring Screw
13704	Handle Washer	13966	Shellplate Platform Bolt
13707	Follower Rod	13967	Primer Seating Punch, Large
13719	Cartridge Spring Retainer Screw	13968	Toolhead
13720	Index Sprocket	13979	Primer Retain Pin Spring
13734	Parts Box	13996	Primer Punch Set Screw
13747	Link Arm, Right w/Hook	13997	Index Ball Spring
13757	Primer Seating Punch, Small	13998	Spent Primer Catcher Pin
13765	Roller	13999	Primer Pickup Tip, Yellow, Small
13775	Main Shaft	14001	Roller Pin
13781	Shellplate Platform	14003	Flexible Orifice, Red, Large
13789	1/4-2/8 Set Screw	14008	Toolhead Pin
13793	Roller	14010	Primer Pickup Tip, Green, Large
13794	Shellplate Bolt	14013	Roller Bracket Screw
13795	Machine Cover	14014	Primer Housing Screw
13799	Stripper Wing Nut	14015	Primer Track Bearing
13801	Tinnerman Nut Insert	14023	8-32x3/4 BH Screw
13803	Ejected Cartridge Chute Bracket	14024	Flexible Orifice, Blue, Small
13824	Primer Seating Cup, Large	14025	Primer Slide Return Spring Retainer
13825	Primer Seating Cup, Small	14033	Spring
13830	Main Shaft Pivot Pin	14037	Clamp/Bracket Screw
13834	Solid Link Arm Pin, Left	14040	Retaining Clip
13839	Cartridge Collection Bin	14051	Primer Retaining Pin
13841	Nylock Nut	14067	Die Lock Ring
13845	Collar Sleeve	14202	Powder Measure Tube Screw
13848	Bellcrank Bushing	14280	Roller Bracket Shell Platform
13850	Operating Handle Knob	14281	Primer Slide Assembly, Large
13857	Battery Cover	14282	Primer Slide Assembly, Small
13864	Switch Lever	17085	Dispensing Tip, Large
13869	Operating Rod	17086	Dispensing Tip, Small
13871	Bellcrank Cube	18086	Shoulder Washer
13879	Primer Magazine, Blue, Small	20048	Spare Parts Kit
13881	Hollow Link Arm Pin, Right	20059	Primer Pickup Tube, Yellow, Small
13882	Powder Measure Lid	20060	Primer Pickup Tube, Green, Large
13885	Return Bracket	20062	Powder Bar Assembly, Small
13887	Operating Rod Bracket	20063	Powder Bar Assembly, Large
13889	Primer Slide Roller	20064	Powder Die
13890	Spring Washer	* 20093	Shellplate
13891	Index Ball	20094	Frame
13893	Powder Bar Post, Large	20263	Primer Feed Body w/ Shield
13898	Primer Slide Stop Nut	20302	Primer Early Warning System
13899	Spent Primer Catcher Chute	20303	Powder Measure Failsafe Kit
13904	Bellcrank Bolt, New Style	20339	Bellcrank
13917	Roller Clip	20636	Operating Handle Assembly
13919	Slide Roller Post	20782	Powder Measure System
13920	Primer Slide	21275	Connector Body Collar
13921	Powder Bar Spacer Plug	22038	Crank Assembly
13923	Brass Tip Set Screw	22273	Powder Body w/ Drop Tube
13924	Slide Post	97000	Rod
13925	Ejector Wire		
13926	Cartridge Spring		
13928	Primer Slide Return Spring		

\* Indicates caliber specific parts. See the caliber conversion chart for the correct part number for the caliber you are loading for.

*Some items listed are not shown in schematic illustration.*









## Introduction

First of all, the Dillon RL 550B is a remarkably simple machine—a little care and thought while setting up will save you time and give you thousands of trouble free rounds.

### Suggested Minimum Equipment:

- 1) Loading Manual
- 2) Powder Scale
- 3) Safety Glasses
- 4) Primer Flip Tray \*
- 5) Dial Caliper \* (\* Indicates items that are not absolutely essential, but are pretty darned handy!)

### Mounting the RL 550B to your bench.

Place your RL 550B on the edge of sturdy bench or table. Give yourself about 12 inches of work space on each side of

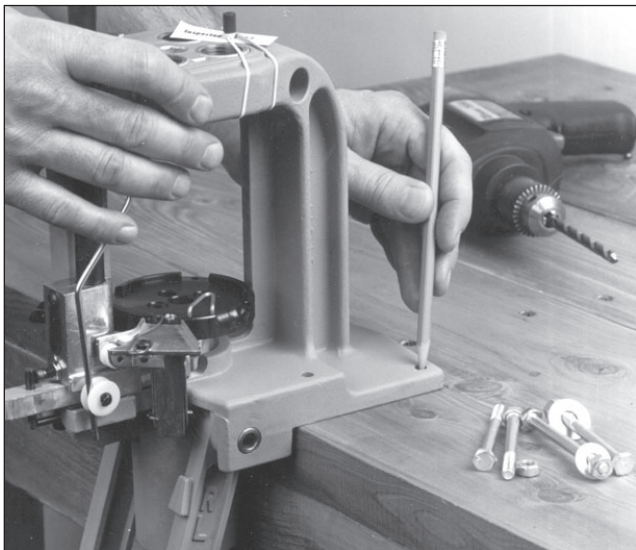

**Fig. 1 - Using the machine as a template, mark and drill four 1/4 inch holes allowing 12 inches on each side for your work area.**

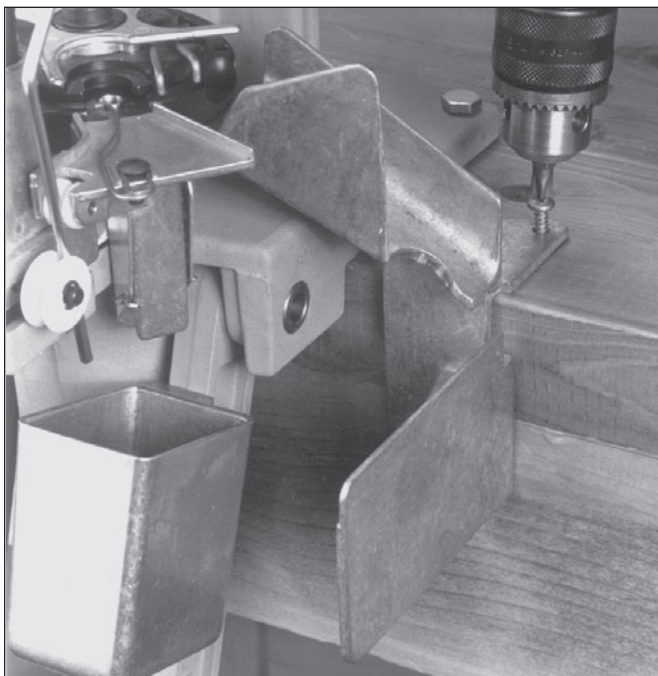

**Fig. 2 - This photograph shows the correct mounting position of the cartridge collection bin bracket in relation to the machine.**

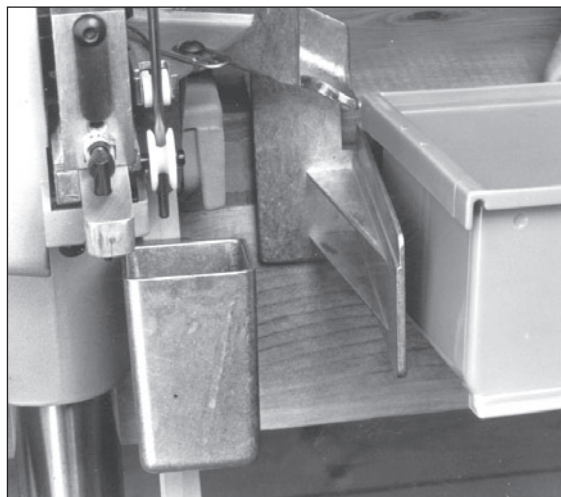

**Fig. 3 - The cartridge collection bin (#13839) simply slides onto the bracket and will be in the proper position.**

the machine to allow room for components.

Using the machine itself as a template, mark and drill four one-quarter inch holes in your bench and bolt your RL 550B securely to it, **Fig. 1**. Next, mount the cartridge collection bin bracket (#13803) onto your bench, **Fig. 2**, allowing approximately one-eighth inch clearance between the platform (#13781) and the ejected cartridge chute. Using two screws or bolts, secure the bracket to your bench. The cartridge collection bin (#13839) simply slides on the bracket, **Fig. 3**, and will be in the proper position to catch ejected loaded rounds. Bolt the operating handle in place as shown in the schematic.

### Safety Points to Know Before you Begin

Reloading ammunition involves the use of highly explosive primers and powder. Handling these materials is inherently dangerous. You should recognize this danger and take certain minimum precautions to lessen your exposure to injury.

Never operate the machine without ear and eye protection on. Call our customer service department at (800) 223-4570 for information on the wide variety of shooting/safety glasses and hearing protection that Dillon has to offer.

- **PAY ATTENTION:** Load only when you can give your complete attention to the loading process. Don't watch television or try to carry on a conversation and load at the same time. Watch the automatic systems operate and make sure they are functioning properly. If you are interrupted or must leave and come back to your loading, always inspect the cases at every station to insure that the proper operations have been accomplished.
- **SMOKING:** Do not smoke while reloading or allow anyone else to smoke in your reloading area. Do not allow open flames in reloading area.
- **SAFETY DEVICES:** Do not remove any safety devices from your machine or modify your machine in any way.
- **MODIFICATIONS:** Any modifications performed to your machine, or the addition of any unapproved equipment from other manufacturers will void the warranty.

- **LEAD WARNING:** Be sure to have proper ventilation while handling lead components or when shooting lead bullets. Lead is known to cause birth defects, other reproductive harm and cancer. Wash your hands thoroughly after handling anything made of lead.

- **LOADS AND LENGTHS:** Avoid maximum loads and pressures at all times. Use only recommended loads from manuals and information supplied by reliable component manufacturers and suppliers. Since Dillon Precision has no control over the components which may be used on their equipment, no responsibility is implied or assumed for results obtained through the use of any such components.

Seat bullets as close to maximum cartridge length as possible. Under some conditions, seating bullets excessively deep can raise pressures to unsafe levels. Refer to a reliable loading manual for overall length (OAL).

- **QUALITY CHECKS:** Every 50-100 rounds, perform periodic quality control checks on the ammunition being produced. Check the amount of powder being dropped and primer supply.

- **RELOADING AREA:** Keep your components safely stored. Clear your work area of loose powder, primers and other flammables before loading.

- **COMPONENTS:** Never have more than one type of powder in your reloading area at a time. The risk of a mix-up is too great. Keep powder containers closed.

Be sure to inspect brass prior to reloading for flaws, cracks, splits or defects. Throw these cases away.

Keep components and ammunition out of reach of children.

- **BLACK POWDER:** Do not use black powder or black powder substitutes in any Dillon powder measure. Loading black powder cartridges requires specialized loading equipment and techniques. Failure to do so can result in severe injury or death.

- **PRIMERS:** Never force primers. If they get stuck in the operation of the machine, disassemble it and gently remove the obstruction.

Never attempt to clear primers that are stuck in either the primer pickup tube or the primer magazine tube. Never, under any circumstances, insert any type of rod to attempt to force stuck primers out of these tubes. Trying to force primers out of the tube will cause the primers to explode causing serious injury or even death.

If primers get stuck in a primer magazine or pickup tube flood the tube with a penetrating oil (WD-40), throw the tube in the garbage and call us for a free replacement.

Never attempt to deprime live primers – eventually one will go off. When it does it will detonate the others in the spent primer cup. Depriming live primers is the single most dangerous thing you can do in reloading and can cause grave injury or death.

- **LOADED AMMUNITION:** Properly label all of your loaded ammunition (Date, Type of Bullet, Primer, Powder, Powder Charge, etc.).

- **BE PATIENT:** Our loading equipment is conservatively rated and you should have no trouble achieving the published rates with a smooth, steady hand. If something doesn't seem right, stop, look and listen. If the problem or the solution isn't obvious, call us. The reloading bench is no place to get into a hurry.

We have done everything we know how to make your machine as safe as possible. We cannot, however, guarantee your complete safety. To minimize your risk, use common sense when reloading and follow these basic rules.

- **REMEMBER:** If your machine does not perform to your expectations, or if you are having technical difficulties, give us a call.

## TO BEGIN LOADING



**Fig. 4 - This photo shows a complete caliber conversion; the powder funnel, shellplate and locator buttons.**

Now that everything is bolted down and you understand the safety precautions, you can proceed.

First, decide what caliber you want to reload and take the shellplate (\*#20079) from the caliber conversion box, **Fig. 4**. Now, in your parts box, find a bag containing; index ball (#13891), shellplate bolt (#13794), index ball spring (#13997), set screw (#13923), and index sprocket (#13720).

Insert the index ball spring (#13781) in the platform as shown in **Fig. 5**. Next set the index ball on top of the index ball spring. Now place the shellplate (number up) over the index ball spring and index ball, **Fig. 6**.

Place the index sprocket on top of the shellplate (making sure the locator posts go into the corresponding holes in the shellplate, see **Fig. 7**).

Next, insert the shellplate bolt through the sprocket and plate and into the center hole of the platform, **Fig. 8**. Tighten with the supplied Allen wrench to the point where you are unable to turn the sprocket by hand. Now, back off the bolt slightly, allowing you to push the sprocket easily with your thumb, **Fig. 9**. There should be no looseness or slop at this point and when you rotate the plate, you should be able to feel and hear the index ball "click" into place under the shellplate.



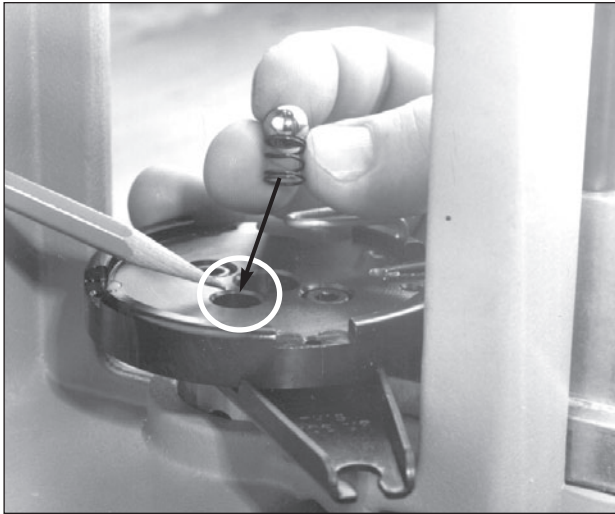

**Fig. 5** - This photo shows the index ball spring and index ball being placed in the platform.

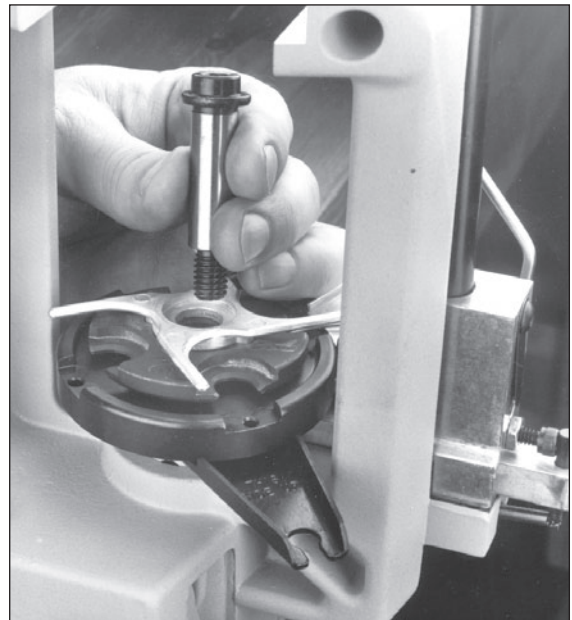

**Fig. 8** - Inserting the shellplate bolt, first through the index sprocket then the shellplate.



**Fig. 6** - Showing the shellplate in its proper position: under the ejector wire with the shellplate number up.

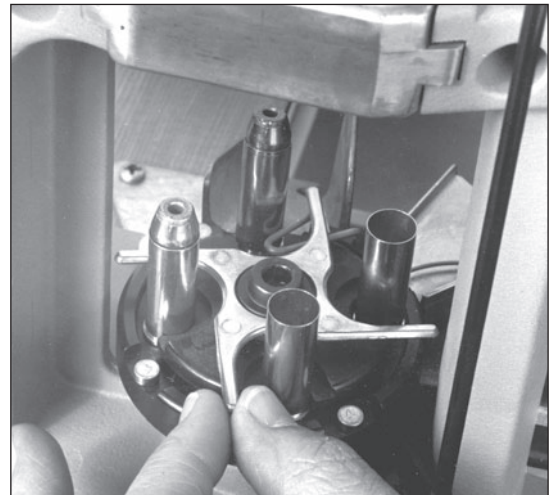

**Fig. 9** - This photo shows the proper method of indexing the shellplate and the proper installation of the locator buttons.

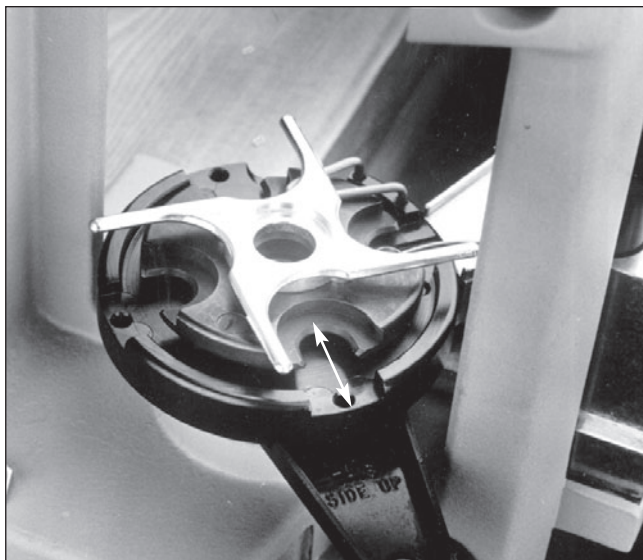

**Fig. 7** - This photo shows the index star in its proper position: the locating tabs centered in the shellplate.

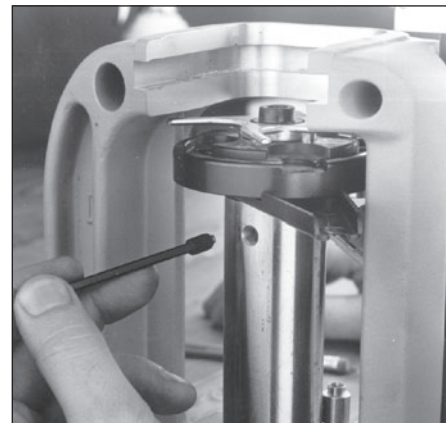

**Fig. 10** - Insert the brass tipped set screw (#13923) and tighten securely.

Take the brass tipped set screw (#13923) insert and tighten securely in the tapped hole beneath the platform on



the left side of the main shaft, **Fig. 10**. This will keep the shellplate from tightening as you use the machine. This screw must be loosened when changing calibers, something that is often forgotten as it's out of sight.

In your caliber conversion box, you will find three brass locator buttons. These simply drop into the three remaining holes in the platform, **Fig. 9**. These "buttons" hold the cases securely in place while you are reloading, but by removing them, allow you to take out a troublesome case, should that occur in your reloading process.

### How To Change Primer Size

Your RL 550B has been shipped to you with the primer system installed and correctly adjusted to feed large primers. If the caliber you have selected to start with requires small primers, you must change to the small primer slide bar.

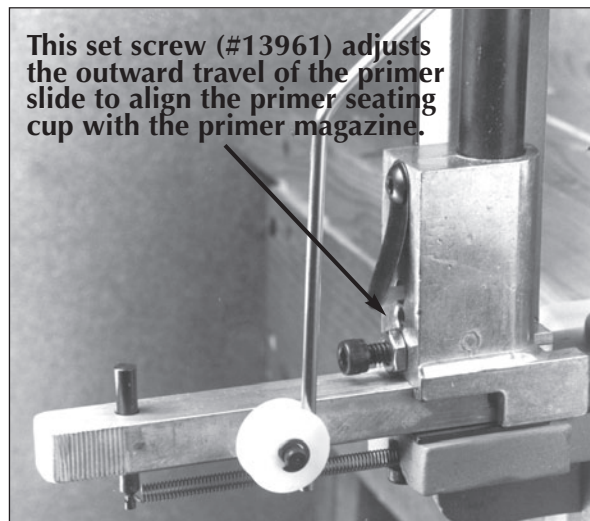

This set screw (#13961) adjusts the outward travel of the primer slide to align the primer seating cup with the primer magazine.

**Fig. 12** - The operating rod has moved the primer slide into the primer feed body where it will automatically pick up a primer.

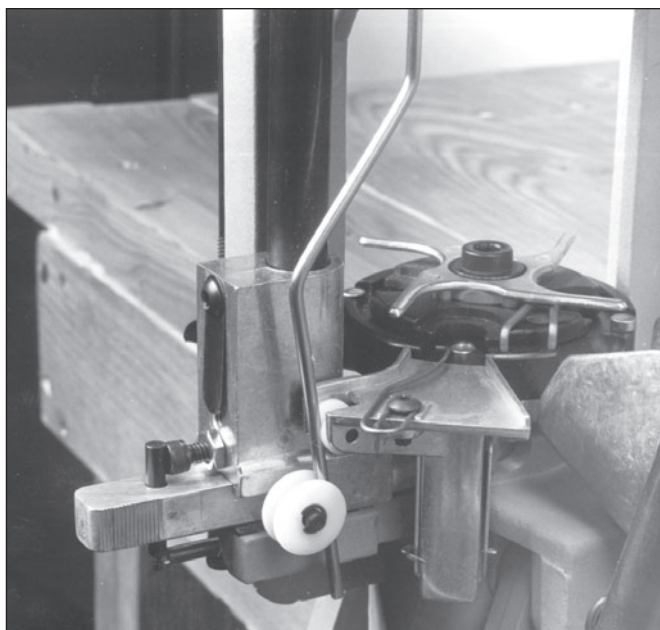

**Fig. 11** - This is the proper alignment of the operating rod and the position of the primer slide fully forward with the primer seating cup in the lowered platform.

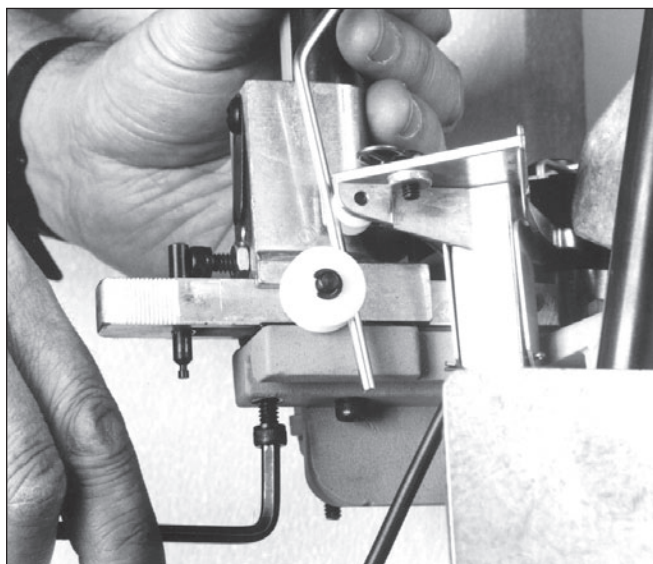

**Fig. 13** - Removing the primer feed body to change primer slides. Caution do not over tighten these bolts (#14014).

Observe carefully how the factory-adjusted bar fits, **Fig. 11**. Raise and lower the platform and notice the alignment of the primer seating cup (\*#13824) as it enters the platform. This adjustment is made by turning the cap screw (#14037) on the primer feed body, **Fig. 12**. Now remove the two screws from beneath the frame under the primer feed body, **Fig. 13**. Unhook the spring and remove the primer slide. To replace, reverse this procedure.

The operating rod (#13869) must be installed between the two white rollers before operating the primer slide. Refer to **Fig. 12** for the proper placement of the rod. Unscrew the knurled cap (#13957) and remove the large primer magazine and replace with the small primer magazine tube, **Fig. 14**; the plastic tip should look like the one you just took out. Replace the knurled cap.

Wait until you've finished assembly before actually placing primers in the magazine.

You will notice that the primer magazine tube tips are different colors and have an indexing ridge on the tip. The

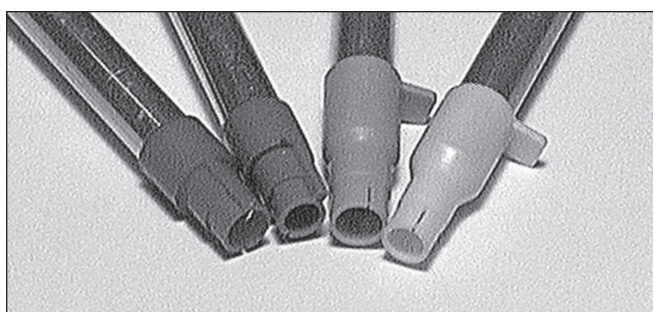
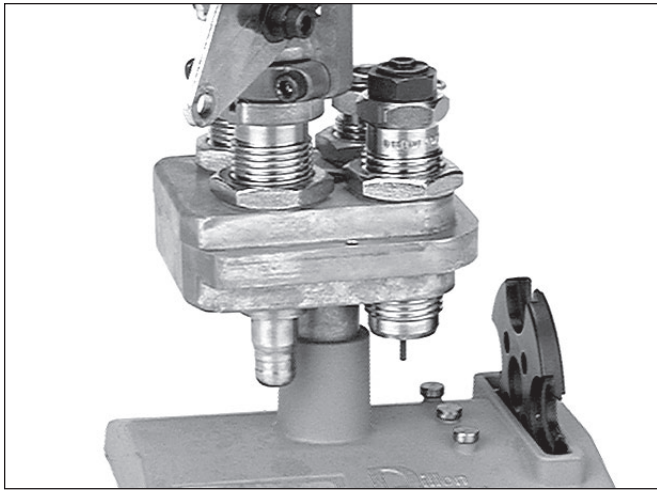

**Fig. 14** - The machine comes with two primer pickup tubes (#20060 large, #20059 small) and two primer magazine tubes (#22031 large, #22030 small). They are color coded for easier identification. See page 13 for color coding information. The large ones should be used together and the small ones should be used together.

magazine tips and the primer pick-up tube tips are color coded to help identify their size, see page 13 for more information. The indexing ridge is to help you place the magazine in its proper position in the primer feed body.

## The Toolhead

Your new RL 550B has been shipped to you with one removable toolhead. Additional toolheads are available from the factory.



**Fig. 15 - A complete, removable toolhead with all of the dies adjusted. Toolhead stand optional.**

The advantage of this system is simple, once your dies have been adjusted just the way you want them, they can stay that way. Plus, changing to another caliber becomes a simple matter of pulling two pins and sliding the toolhead out, **Fig. 15**.

## Choose Your Dies

Your RL 550B will perform well with any manufacturer's standard 7/8 x 14 die. However, for ease of use in your RL 550B, the dies should have a radius on the lead-in portion of the die; that is to say a taper or funnel effect to assist the entrance of the case into the die. This is especially recommended on the sizing die.

We also recommend the use of separate bullet seating and crimp dies for pistol cases. Simultaneous seating and taper crimping of semi-auto cases is not recommended. Why?

Two reasons. First, in a combination seating and crimping die, we have two forces that are opposed to one another. That is, forcing the bullet into the case while trying to simultaneously crimp it in place. A better idea is to seat the bullet in one die and then crimp it in place in another.

Second, with semi-auto cases (9mm & .45 ACP) you must use a separate taper crimp die to get reliable ammunition and function from your semi-automatic pistol. This type of crimp is necessary to maintain the square shoulder effect where the brass edge of the case meets the bullet. It is on this tiny shoulder that the functioning of your semi-auto pistol depends. If this shoulder is rounded or roll-crimped, the cartridge may enter too far into the chamber and jams will result. On revolver ammunition, where the cartridge headspaces on the rim of the case, this type of crimp is not as important, but once again, by using a separate crimp die, you will obtain better and more uniform bullet seating.

## Carbide Dies?

All Dillon pistol resizing dies are manufactured with a carbide insert. Carbide is one of the world's hardest materials and will last the average reloader a lifetime. It also takes a high polish and being more dense is smoother than a steel die. Besides its longevity, it has another advantage. All steel dies require lubrication of your brass before resizing, but with a carbide pistol resizing die this is not absolutely necessary. Lubrication will make sizing easier, but with a carbide pistol die, it is not required.

However, when using carbide rifle dies, your cases must always be lubricated.

The advantage of carbide rifle dies is their long life and scratch resistant qualities. If you are a commercial reloader, you may want to consider them.

**Setting your Rifle Dies: See the separate instruction booklet supplied with the rifle dies.**

## Setting your Pistol Dies

Before you begin, make sure that the toolhead is secured by the toolhead pins (#14008).

## Station One

You will notice an adjustable retaining spring at Station One, **Fig. 16**. This spring should be adjusted to almost contact the case when it's placed in the shellplate.

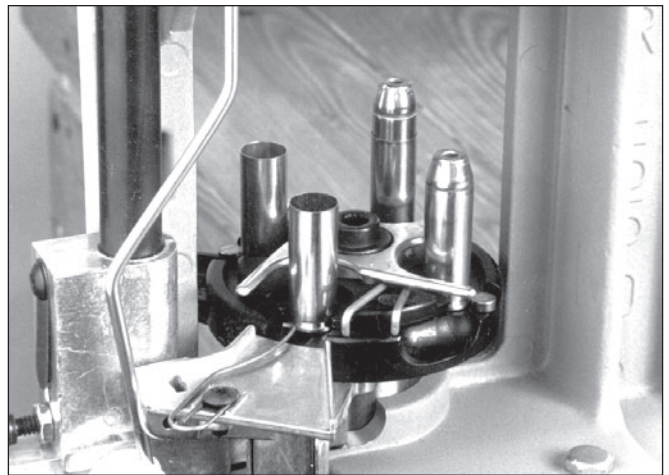

**Fig. 16 - A fully loaded shellplate, directly below the proper dies. Clockwise from Station One, the cartridge at this station is resized, deprimed and reprimed. Station Two bells the case mouth (pistol only) and dispenses the powder. Station Three seats the bullet. Station Four crimps the bullet.**

In the first station, **Fig. 16**, brass is resized, deprimed, and then reprimed.

Using the die lock rings provided, screw the sizing die into the toolhead. Raise the platform and screw the die down until it touches the shellplate. Lower the platform and insert an empty case into Station One. Raise the platform so the case is in the die, tighten the lock ring on the die. This will keep everything centered. The decap assembly should be screwed fully into the die at all times.

A note of caution, never attempt to deprime a live primer. An explosion may result.



## Station Two

Here, the powder is dropped and the mouth of the case is belled. This is where the Automatic Powder System is installed.

The powder die is located in the automatic powder measure assembly, you will need to retrieve it before you can continue. See the schematic on page 4.

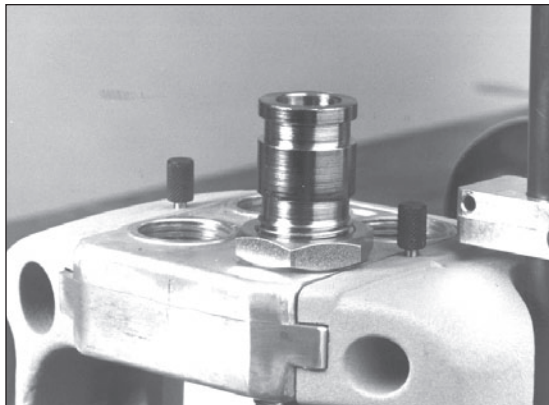

**Fig. 17** - This photo shows the powder die in its correct position (Station Two) in the toolhead. The powder die may be higher or lower depending on the caliber it is being adjusted for.

Now, screw the powder die (#20064) into the toolhead, **Fig. 17**. Next, insert the pistol powder funnel (\*#13782) or a rifle powder funnel (\*#13426) with the tapered end down, **Fig. 18**. The funnel should move freely in the die.



**Fig. 18** - Drop the powder funnel into the powder die tapered end first. The funnel should move freely in the die.

Set the powder measure assembly onto the powder die, **Fig. 19**. The powder measure clamp (#13939) should fit loosely around the die, tighten the screws just a little. This will enable you make adjustments to the die easily, **Fig. 19**.

On rifle cases, the die should be adjusted so that the powder funnel will contact the mouth of the case and then fully actuate the powder bar, **Fig. 20 & 21**. These adjustments are accomplished with a case in the shellplate and alternately raising and lowering the operating handle, while adjusting the powder die, **Fig. 19**. When properly adjusted, the powder bar will be moved to its full rearward

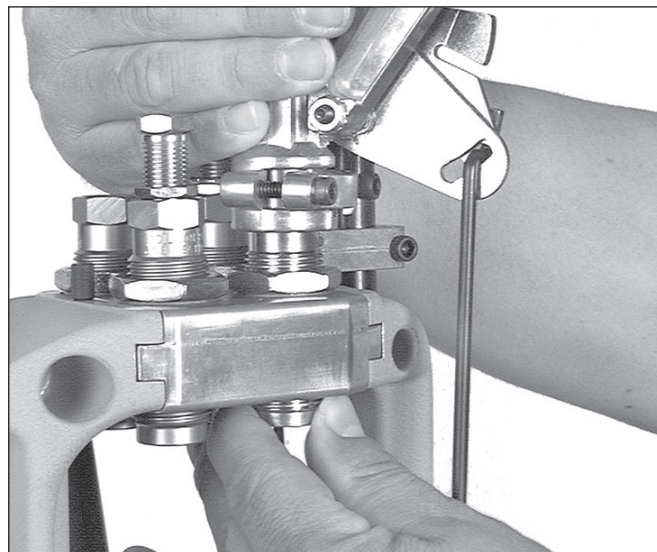

**Fig. 19** - The powder die can be easily adjusted by turning the die beneath the toolhead while holding the powder measure securely from above.

(open) position by the case, **Fig. 20 & 21**, while the handle is at the full up position. When you have determined that your adjustments are correct, tighten the die lock ring.

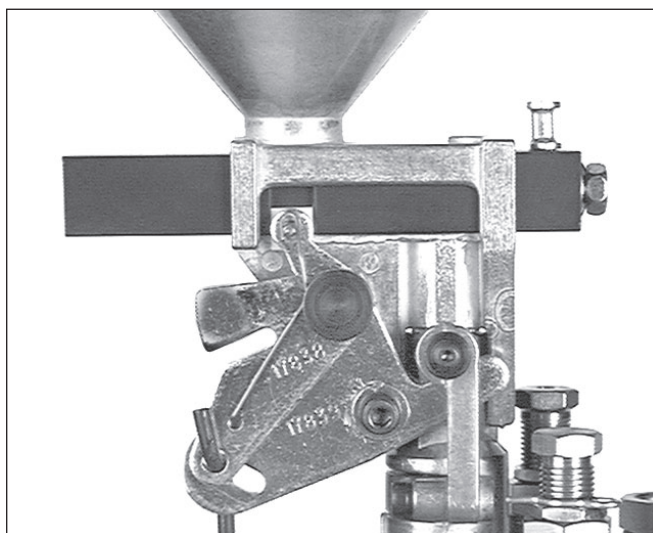

**Fig. 20** - This photo shows the large powder bar in its closed position. Note the position of the white bellcrank cube. (Primer system removed for clarity.)

On pistol cases, once the powder bar travels fully across you should continue to adjust the powder die for the desired amount of bell (turn the powder die 1/8 of a turn at a time). The desired amount bell is just enough to allow the bullet to sit on the case mouth without falling off and to keep the case from shaving lead during the seating process (see "A" **FIG 22**).



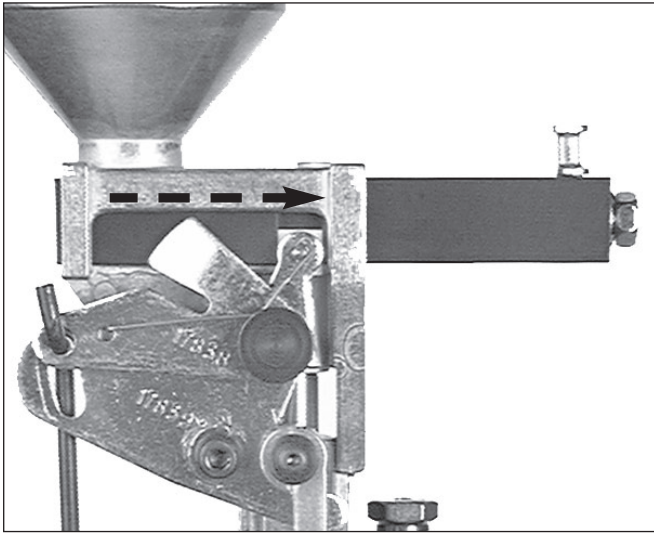

**Fig. 21** - This photo shows the large powder bar in its fully open (rearward) position. Note the position of the white bellcrank cube. (Primer system removed for clarity.)

Note: If you screw the die down too far the case will look like example “C” FIG 22. You must then discard this case, back the powder die off, by turning it counter-clockwise, and continue with a new sized case.

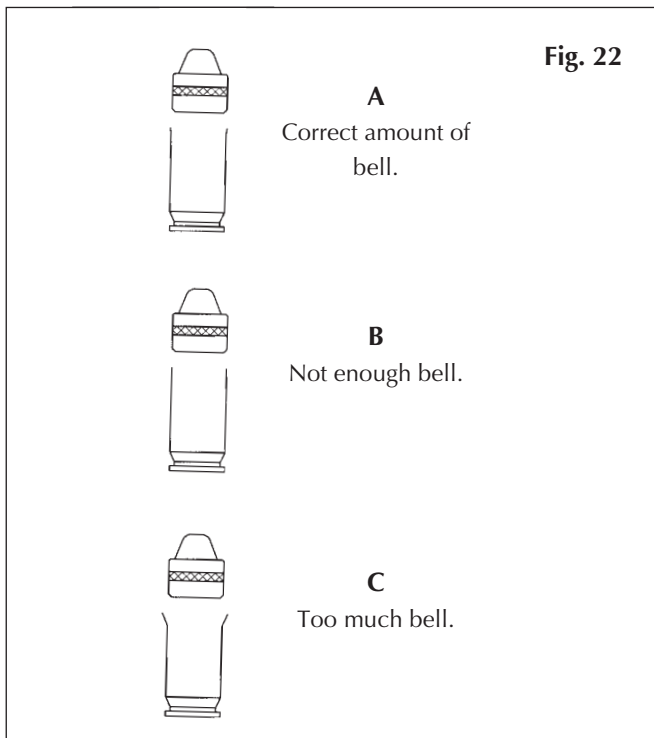

You’ll soon learn to judge the correct amount of bell by simply looking at it. In the meantime, you might want to use your dial calipers to check it. Twenty thousandths of an inch greater (at the mouth of the case) than its original diameter, should about do it.

Once you’ve achieved the desired amount of bell – with the case in Station 2, raise the platform. Turn the die locking down hand tight.

Be aware that new brass will often “stick” on the powder funnel or cause resistance on the upstroke. Cleaning the

brass in a tumbler should help.

Next, attach the powder measure fail safe rod assembly to the bellcrank (#17839). Using your thumb and index finger of your right hand, move the lock-link down to align the hole with the slot on the Powder Measure bellcrank (#17839). Then insert the rod (#97000) through the two holes, **Fig. 20**. Next, lower the operating handle (#20636). Insert the powder measure rod into the slot in the return bracket (#13885) press the shoulder washer into the slot from the bottom. Move the operating handle to the priming position, press the operating handle firmly forward. Tighten the blue wingnut (#13799) until the top of the spring (#14033) just touches the underside of the return bracket (#13885). Release the operating handle to the up/rest position. Now, tighten the screws on the body collar clamp (#13939).

We’ll come back to filling the measure with powder and adjusting the bar. The purpose of the powder measure failsafe rod (#97000) is to return the powder bar to its closed position.

### Station Three

In this station the bullet is seated to its proper depth. You need to refer to a loading manual for overall length of the completed round. Overall length (OAL) may vary up to .016”, and this is normal.

Put a case into the shellplate at Station Three. Raise the platform up and screw the die down until it just touches the shellplate and back it out two turns. Now, back your seating stem out.

Place a bullet on the case and operate the handle. Using a dial caliper or case gage, check for overall length. Keep screwing the seating stem down in small increments until the correct overall length is achieved. Once you are satisfied with the overall length, tighten the lock ring.

### Station Four

The crimping operation is performed at this station.

Insert the crimp die and place an empty case in Station Four. Raise the platform and screw the crimping die down until it touches the rim of the case. Now lower the platform and screw the die down an additional one-quarter of a turn. Place a round in Station Four with a seated bullet and cycle the operating handle.

You will need to refer to a loading manual to get proper crimp dimensions for the caliber you are loading. A dial caliper is required to take accurate measurements from your crimped round.

If more crimp is needed, screw the crimp die down in small increments until you get the desired crimp, now tighten the lock ring.

## Adjusting the Powder Charge

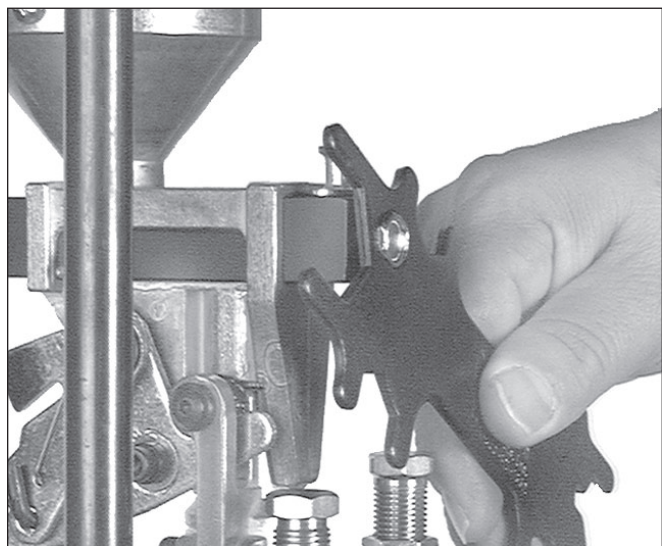

**Fig. 23** - Turning the bolt counter clockwise reduces your powder charge, clockwise increases the charge.

You will notice an adjusting bolt on the back of the powder bar, **Fig. 23**. Turning the bolt counter-clockwise reduces your powder charge, clockwise increases the charge. Your machine comes with two powder bars – one large and one small.

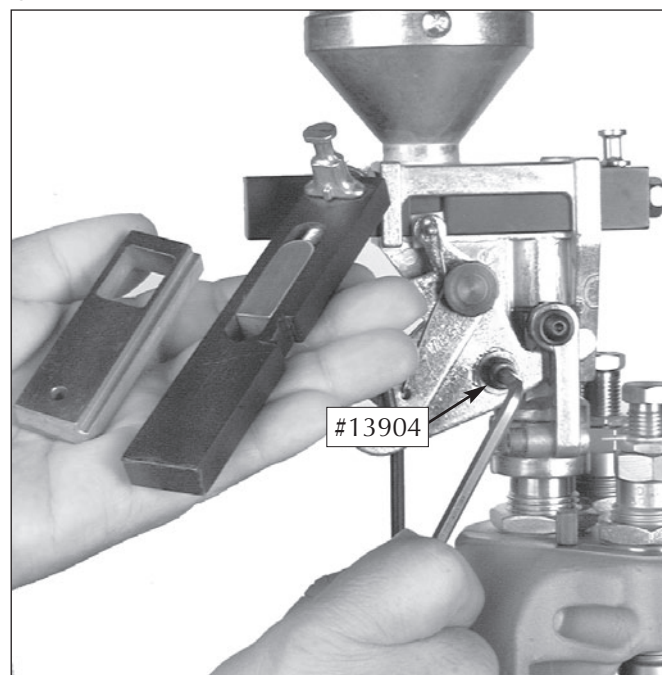

**Fig. 24** - After emptying the powder measure, loosen the bellcrank screw (#13904) sufficiently to allow you to remove the powder bar. Insert the new powder bar and reverse this procedure.

Rule of thumb: Use the large bar whenever possible—see page 15. These bars are easily changed, **Fig. 24**. Use a reloading manual to determine how much powder you need for a particular load and an accurate powder scale to determine the weight. A high quality precision powder scale is available from Dillon. You should now fill the powder measure with your chosen powder. Place an empty case under the measure and operate the machine's handle. Then,

by trial and error adjustments, determine the correct weight of your powder charge. You are now ready to fill the primer magazine.

## Primer Early Warning System Installation

(See item #20302 on page five for assistance.)

Remove the follower rod (#13707) from the assembly bag and set it aside. Install the battery and the battery cover (#13857) in the system's main body. Slide the Early Warning System assembly down over the knurled cap on your primer magazine (#13957) and lightly tighten the clamp screw.

## Primer Magazine

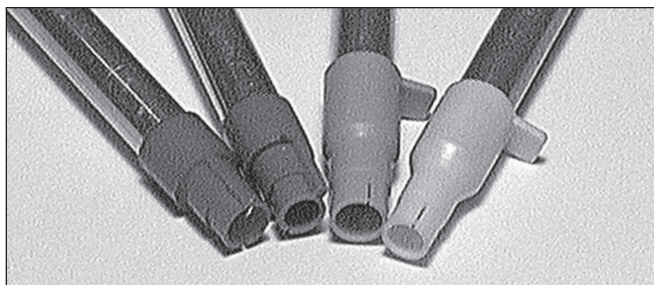

**Fig. 14** - The machine comes with two primer pickup tubes (#20060 large, #20059 small) and two primer magazine tubes (#22031 large, #22030 small). They are color coded for easier identification. See color coding information below. The large ones should be used together and the small ones should be used together.

You will notice that the primer magazines and primer pick-up tubes have different colored tips. They have been color coded to help you identify size more easily.

The color code is as follows:

Blue	Small Primer Magazine Orifice
Red	Large Primer Magazine Orifice
Yellow	Small Primer Pick-up Tube
Green	Large Primer Pick-up Tube

Select the proper size pick-up tube and fill it by placing the plastic expandable tip over loose primers and pressing down. The shiny sides of the primers need to be facing up, **Fig. 25**.

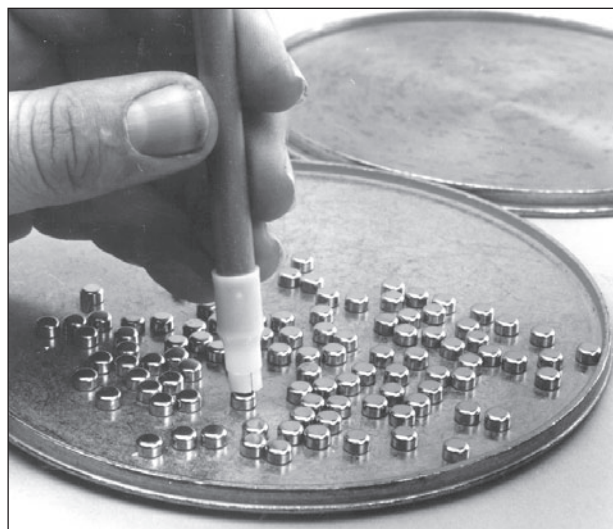

**Fig. 25** - Use of the primer pickup tube and the Dillon Primer flip tray.



This is most easily accomplished by using a primer flip tray, which will arrange them all for you, **Fig. 25**. A quality cast metal flip tray is available from Dillon and is a better choice than the smaller plastic trays which are difficult to use and have a tendency to warp.



**Fig. 26 - Drop the primers into the primer magazine.**

Once you've filled the pick-up tube, make sure the little retaining clip is in place at the top of the tube. Pivot the switch lever (#13864) away from the Early Warning System housing. Invert the pick-up tube over the knurled cap (#13957) of the primer magazine, **Fig. 26**. You will notice the cap has a bevel to help you funnel the primers in. Hold the tube in place, pull the retaining clip and allow the primers to drop into the magazine. Pivot the switch lever back over the Early Warning System housing. Gently slide the follower rod down into the primer magazine tube until the follower rod touches the primers.

When you are nearly out of primers (about three left) the follower rod (#13707) will activate the buzzer.

A word of caution: primers are easily detonated, sometimes by a remarkably light blow. Treat them as if they are as fragile as eggs. Never force them.

## At Last

If you've followed instructions, you are now ready to load.

Many reloaders develop their own style when using the RL 550B. But, let me explain the most efficient method. Try it and later, if you want to make changes in your technique, go ahead.

Place your bullets in a box to the left of the RL 550B and the empty cases in a box to the right. A few extra cartridge collection bins (#13839) are ideal for this.

Now, with your right hand, place a case in Station One and smoothly pull the operating handle. This resizes and decaps this case, at the same time your primer slide should

be automatically carried back to the primer magazine, where it will pick up a primer. Now, raise the handle smoothly. The primer slide (#13920) will come forward with a primer and place it under the deprimed case. If you are using the handle gently, you will feel the primer contact the primer pocket. Press forward firmly until the handle stops. Your primer will now be seated.

Advance the case to the second Station by pressing on the index sprocket (#13720) with your left thumb. Place another empty case into Station One and pull the operating handle. Station One will repeat as before. Station number two will bell the case mouth and dispense the powder. Again, raise the handle, index with your thumb and place a bullet on the powder charged case at Station Three with your left hand, **Fig. 7**. With your right hand, install a new case at Station One and pull the handle. Stations one and two will repeat as before.

Station Three will seat the bullet. Index with your left thumb and put in a bullet. Put an empty case into Station One with your right and operate the handle. Stations one, two and three will repeat: Station Four will have crimped the bullet. Index again and your first completed round will tumble into the cartridge collection bin. Now just add a bullet and a case. Each time you operate the handle you'll get a loaded round. Works good, right? If not, go back over the procedure.



## Lubrication

Use 30 weight motor oil on the main shaft and bearing grease on the pivot pins. Do not use spray type penetrating lube such as WD40 or Break Free as you run the risk of contaminating powder and primers.

## Troubleshooting

### Problem One. Primers not seated deep enough.

- A. Shellplate too loose.
- B. Shellplate upside down. You should be able to see a stamped shellplate number facing up.
- C. The crimp in the primer pockets of military brass will cause this problem. Crimps can be easily removed by use of a Dillon Primer Pocket Swage.

### Problem Two. Erratic powder bar operation:

- A. Turn the powder die (#20064) clockwise in one-eighth turn increments. This will insure complete powder bar activation.
- B. Extruded pencil type powders will not flow smoothly through smaller sized powder funnels because of their length. Another problem with extruded powders is getting them into small necked cases. Many times these powders will “bridge” across the case mouth and cause spillage and erratic charges. There is no fast way of dispensing these powders and if you insist on using them in small mouthed cases it is best to weigh every charge by hand. Modern ball type powders will do for most reloading situations. These powders will do everything the pencil powders will do, but without this problem. Warning: Do not use I.M.R. pencil lead type powder in cases smaller than .30 caliber.

### Problem 3. Primer jams or misfeeds.

- A. Primer misfeeds can be caused by misadjustment of the set screw (#13961) in the primer feed block, **Fig. 12**.
- B. The most common cause of primer misfeeds or jams is the primer punch not seated fully into the primer slide. This will cause the primer seating cup to strike the flexible orifice on the bottom of the primer magazine tube. See the photograph on page 5 for adjustment tolerances.

**WARNING:** If the primers are jammed and will not feed from the bottom of the primer magazine, **DO NOT ATTEMPT TO FORCE THE PRIMERS OR THE PRIMER SLIDE**. Never force primers in any situation, an explosion resulting in injury can occur.

- C. Another common problem is that the primer slide fails to return fully forward with the new primer. Periodically wipe the primer slide with rubbing alcohol. This removes the spent primer residue that causes the slide to drag.

### Problem 4. Crushing cases:

- A. If your dies do not have a radiused lead-in you must guide the cases into the die. The best solution is to replace the offending dies with dies having the proper radius.
- B. Always tighten your die lock rings with a case in the die. This will assure you of proper alignment between the die and the shellplate. Adjust your depriming stem in the same manner and it will always be on center.

## REMEMBER

Be sure to use the necessary precautions when loading lead bullets or when casting lead bullets. Exposure to lead can cause cancer, birth defects, and reproductive problems. Be sure to wash your hands thoroughly after handling lead. When firing lead bullets, be sure that you have adequate ventilation. Keep any lead items out of reach of children.

Press forward firmly on the handle once it is at the aft position to seat your primers fully.

Watch the powder bar function to make sure you're getting powder.

Set the bullet straight on the case at Station Three so that it enters the die correctly.

Watch your supply of powder, you'll be using it faster than you think you are.

Take your time and learn the machine and its function. The RL 550B will deliver hundreds of trouble free rounds in short order, just relax and take your time in the beginning.

Keep it clean – primer residue, spilled powder and just plain dirt can jam your machine.

Clean your powder bar about every 500 rounds. Some powders build up and will eventually stick the powder bar. Paint thinner, acetone or lacquer thinner works well to remove any build up.

## NOTICE

This machine is designed specifically to be a manually operated handloading machine. Any attempts to automate this product will void any and all warranties offered by the company. We specifically warn against converting this product to automated or motorized operation.

All Dillon machines are warrantied for life from defects in material or workmanship (except the Super/RL 1050), plus a one year 100% warranty against normal wear. All electrical/electronic components in Dillon equipment are covered by a one year warranty.

### About Powder Bars:

Dillon Precision manufactures four types of powder bars.

1. Extra Small – use for dropping less than 3 grains of powder
2. Small – use for dropping 3 to 20 grains of powder
3. Large – use for dropping 20 to approximately 45 to 50 grains of powder
4. Magnum – use for dropping 50 or more grains of powder

The extra small powder bar is used when loading .32 Auto, .32 S&W and .32 SWL. Both the extra small powder bar and the magnum powder bar are non-standard items and are ordered separately. The large and small powder bar are standard equipment and are included with every reloader.

# RL 450 & RL 550B Caliber Conversion Chart

Kits include shellplate, locator buttons and flow-thru powder funnel.

## Handgun-Caliber Conversions

### .22 Remington Jet - # 20165

#2 Shellplate - # 13751  
#A Powder Funnel - # 13426  
#2 Locator Pin - # 14062

### .30 Luger, .30 Mauser - # 20175

#5 Shellplate - # 13743  
#C Powder Funnel - # 13564  
#3 Locator Pin - # 14060

### .32 ACP, .32 Short Colt - # 20160

#J Shellplate - # 13136  
#S Powder Funnel - # 12845  
#8 Locator Pin - # 14048

### .32 S&W Long, .32 H&R Magnum - # 20146

#D Shellplate - # 13092  
#S Powder Funnel - # 12845  
#3 Locator Pin - # 14060

### .32-20 Winchester - # 20177

#O Shellplate - # 12013  
#S Pistol Powder Funnel - # 12845  
#3 Locator Pin - # 14060

### .380 ACP - # 20133

#3 Shellplate - # 13684  
#F Powder Funnel - # 13806  
#3 Locator Pin - # 14060

### 9x18 Makarov - # 21656

#5 Shellplate - # 13743  
#9 Powder Funnel - # 14980  
#3 Locator Pin - # 14060

### 9mm, .38 Super - # 20127

#5 Shellplate - # 13743  
#F Powder Funnel - # 13806  
#3 Locator Pin - # 14060

### 9x25 Dillon, .357 Sig - # 21526

#5 Shellplate - # 13743  
#F Powder Funnel - # 13806  
#2 Locator Pin - # 14062

### .38 S&W - # 20159

#U Shellplate - # 12944  
#F Powder Funnel - # 13806  
#2 Locator Pin - # 14062

### .38 AMU - # 20278

#O Shellplate - # 12013  
#D Powder Funnel - # 13599  
#3 Locator Pin - # 14060

### .38 Special, .357 Mag, .38 LC - # 20132

#2 Shellplate - # 13751  
#D Powder Funnel - # 13599  
#2 Locator Pin - # 14064

### .38-40 Winchester - # 20178

#N Shellplate - # 10004  
#W Pistol Powder Funnel - # 13600  
#4 Locator Pin - # 14047

### .40 S&W, 10mm - # 20179

#5 Shellplate - # 13743  
#W Powder Funnel - # 13600  
#2 Locator Pin - # 14062

### .40 Super, .400 CorBon - # 20129

#1 Shellplate - # 13692  
#W Powder Funnel - # 13600  
#1 Locator Pin - # 13930

### .41 Action Express - # 20277

#5 Shellplate - # 13743  
#H Powder Funnel - # 13240  
#3 Locator Pin - # 14060

### .41 Magnum - # 20135

#6 Shellplate - # 13120  
#H Powder Funnel - # 13240  
#1 Locator Pin - # 13930

### .44-40 Winchester - # 20206

#N Shellplate - # 10004  
#.44-40 Pistol Powder Funnel - # 13600  
#4 Locator Pin - # 14047

### .44 Spl, Mag, Colt, Russian - # 20136

#4 Shellplate - # 13610  
#G Powder Funnel - # 13427  
#4 Locator Pin - # 14047

### .45 ACP - # 20126

#1 Shellplate - # 13692  
#E Powder Funnel - # 13782  
#1 Locator Pin - # 13930

### .45 Auto Rim - # 20158

#H Shellplate - # 13010  
#E Powder Funnel - # 13782  
#4 Locator Pin - # 14047

### .45 Colt, .455 Webley, .454 Casull, .45 S&W -

#### # 20137

#C Shellplate - # 13334  
#E Powder Funnel - # 13782  
#4 Locator Pin - # 14047

### .45 Winchester Magnum - # 20221

#L Shellplate - # 12703  
#E Powder Funnel - # 13782  
#1 Locator Pin - # 13930

### .460 S&W - # 20888

#C Shellplate - # 13334  
#.460 S&W Powder Funnel - # 18949  
#4 Locator Pin - # 14047

### .475 Linebaugh, .480 Ruger - # 20116

#G Shellplate - # 13313  
#475/480 Ruger Powder Funnel - # 10723  
#7 Locator Pin - # 13436  
(Requires Extra Large Powder Die - # 21253)

### .50 Action Express - # 21428

#50 Shellplate - # 13147  
#50 Act Ex Powder Funnel - # 14465  
#4 Locator Pin - # 14047  
(Requires Extra Large Powder Die - # 21253)

### .500 S&W Mag - # 20121

#B Shellplate - # 13347  
#50 Act Ex Powder Funnel - # 14465  
#6 Locator Pin - # 15755  
(Requires Extra Large Powder Die - # 21253)

## Rifle-Caliber Conversions

### .17 Remington - # 20203

#3 Shellplate - # 13684  
#O Powder Funnel - # 12921  
#3 Locator Pin - # 14060

### .204 Ruger - # 20307

#3 Shellplate - # 13684  
#204 Rifle Powder Funnel - # 20322  
#3 Locator Pin - # 14060

### .218 Bee - # 20151

#O Shellplate - # 12013  
#A Powder Funnel - # 13426  
#3 Locator Pin - # 14060

### .219 Zipper, .22 Savage - # 20180

#7 Shellplate - # 12501  
#A Powder Funnel - # 13426  
#4 Locator Pin - # 14047

### .220 Swift, .225 Winchester - # 20154

#L Shellplate - # 12703  
#L Powder Funnel - # 10831  
#1 Locator Pin - # 13930

### .223, .222, .221 Remington - # 20128

#3 Shellplate - # 13684  
#A Powder Funnel - # 13426  
#3 Locator Pin - # 14060

### .223 WSSM - # 20676

#B Shellplate - # 13347  
#223 Short Mag. Rifle Powder Funnel - # 18417  
#6 Locator Pin - # 15755  
(Requires XL Powder Die #21253)

### .22 Bench Rest, .22-250 - # 20145

#1 Shellplate - # 13692  
#A Powder Funnel - # 13426  
#1 Locator Pin - # 13930

### .224 Weatherby Magnum - # 20235

#A Shellplate - # 13211  
#A Powder Funnel - # 13426  
#2 Locator Pin - # 14062

### .22 Hornet - # 20150

#E Shellplate - # 12957  
#A Powder Funnel - # 13426  
#8 Locator Pin - # 14048

### .22 PPC - # 20182

#A Shellplate - # 13211  
#A Powder Funnel - # 13426  
#2 Locator Pin - # 14062

### .243, .244, 6mm, .240 Wby - # 20192

#1 Shellplate - # 13692  
#1 Powder Funnel - # 13305  
#1 Locator Pin - # 13930

### .243 WSSM - # 20316

#B Shellplate - # 13347  
#243 Short Mag. Rifle Powder Funnel - # 11156  
#6 Locator Pin - # 15755  
(Requires XL Powder Die #21253)

### .25-20 Winchester - # 20176

#O Shellplate - # 12013  
#R Powder Funnel - # 13243  
#3 Locator Pin - # 14060

### .25-06, .250, .257 Roberts, Ackley - # 20147

#1 Shellplate - # 13692  
#K Powder Funnel - # 13216  
#1 Locator Pin - # 13930

### .25-35 Winchester - # 20197

#7 Shellplate - # 12501  
#K Powder Funnel - # 13216  
#4 Locator Pin - # 14047

### .256 Winchester Magnum - # 20215

#2 Shellplate - # 13751  
#R Powder Funnel - # 13243  
#4 Locator Pin - # 14047

### .257 Weatherby Magnum - # 20199

#B Shellplate - # 13347  
#K Powder Funnel - # 13216  
#4 Locator Pin - # 14047

### .25 Remington - # 20233

#R Shellplate - # 13497  
#K Powder Funnel - # 13216  
#2 Locator Pin - # 14062

### .25 WSSM - # 20315

#B Shellplate - # 13347  
#.25 Short Mag. Rifle Powder Funnel - # 11157  
#6 Locator Pin - # 15755  
(Requires XL Powder Die #21253)

# RL 450 & RL 550B Caliber Conversion Chart

Kits include shellplate, locator buttons and flow-thru powder funnel.

## 6mm Bench Rest - # 20276

#1 Shellplate - # 13692  
#6 PPC Rifle Powder Funnel - # 13085  
#1 Locator Pin - # 13930

## 6mm PPC - # 20265

#A Shellplate - # 13211  
#6 PPC Rifle Powder Funnel - # 13085  
#2 Locator Pin - # 14062

## .264 Win Mag, 6.5 Rem - # 20210

#B Shellplate - # 13347  
#Y Powder Funnel - # 12870  
#4 Locator Pin - # 14047

## 6.5x54 Man-Scho - # 20208

#M Shellplate - # 13230  
#Y Powder Funnel - # 12870  
#2 Locator Pin - # 14062

## 6.5 Arisaka - # 20209

#L Shellplate - # 12703  
#Y Powder Funnel - # 12870  
#1 Locator Pin - # 13930

## 6.5 Grendel - # 20894

#A Shellplate - # 13211  
#6.5 Grendel Powder Funnel - # 18947  
#2 Locator Pin - # 14062

## 6.5x55, 6.5x57, .260 Rem - # 20207

#1 Shellplate - # 13692  
#Y Powder Funnel - # 12870  
#1 Locator Pin - # 13930

## 7mm TCU - # 20141

#3 Shellplate - # 13684  
#N Rifle Powder Funnel - # 13014  
#3 Locator Pin - # 14060

## 7-30 Waters - # 20223

#7 Shellplate - # 12501  
#N Rifle Powder Funnel - # 13014  
#4 Locator Pin - # 14047

## 7mm Bench Rest - # 20216

#1 Shellplate - # 13692  
#N Powder Funnel - # 13014  
#1 Locator Pin - # 13930

## 7x57 R, 7x65 R - # 20268

#N Shellplate - # 10004  
#J Powder Funnel - # 13456  
#4 Locator Pin - # 14047

## 7mm Rem Mag, 7mm STW - # 20140

#B Shellplate - # 13347  
#J Powder Funnel - # 13456  
#4 Locator Pin - # 14047  
(Requires Magnum Powder Bar # 21353)

## .270 WSM, 7mm WSM, 7mm RSAUM - # 20122

#B Shellplate - # 13347  
#7mm Short Mag Powder Funnel - # 18416  
#6 Locator Pin - # 15755  
(Requires XL Powder Die # 21253)  
(Requires Magnum Powder Bar # 21353)

## 7mm RUM - # 20682

#B Shellplate - # 13347  
#7mm Mag Powder Funnel - # 15019  
#6 Locator Pin - # 15755  
(Requires Belted Magnum Powder System # 97126)

## .270 Win, 7x57, .284 Win - # 20142

#1 Shellplate - # 13692  
#J Powder Funnel - # 13456  
#1 Locator Pin - # 13930

## 6.8 SPC - # 20323

#R Shellplate - # 13497  
#N Powder Funnel - # 13014  
#2 Locator Pin - # 14062

## .30 M1 Carbine - # 20131

#8 Shellplate - # 13135  
#C Powder Funnel - # 13564  
#8 Locator Pin - # 14048

## .300 Whisper - # 20236

#3 Shellplate - # 13684  
#AK Rifle Powder Funnel - # 13015  
#3 Locator Pin - # 14060

## .300 Winchester Magnum - # 20188

#B Shellplate - # 13347  
#B Powder Funnel - # 13587  
#4 Locator Pin - # 14047  
(Requires Magnum Powder Bar # 21353)

## .300 WSM - # 20215

#B Shellplate - # 13347  
#30Cal Lng Mag Powder Funnel - # 15013  
#4 Locator Pin - # 14047  
(Requires XL Powder Die # 21253)  
(Requires Magnum Powder Bar # 21353)

## .308/.30-06 - # 20130

#1 Shellplate - # 13692  
#B Powder Funnel - # 13587  
#1 Locator Pin - # 13930

## .300 Savage - # 20190

#1 Shellplate - # 13692  
#AK Powder Funnel - # 13015  
#1 Locator Pin - # 13930

## .300 RUM - # 20239

#B Shellplate - # 13347  
#30Cal Lng Mag Powder Funnel - # 15013  
#7 Locator Pin - # 13436  
(Requires Belted Magnum Powder System # 97126)

## .30-30 Win, .32 Win Spl - # 20139

#7 Shellplate - # 12501  
#B Powder Funnel - # 13587  
#4 Locator Pin - # 14047

## .30 Remington, .32 Remington - # 20184

#R Shellplate - # 13497  
#B Powder Funnel - # 13587  
#2 Locator Pin - # 14062

## .307 Winchester - # 20237

#L Shellplate - # 12703  
#B Powder Funnel - # 13587  
#1 Locator Pin - # 13930

## .30-378, .300 Dakota - # 20249

#G Shellplate - # 13313  
#30Cal Lng Mag Powder Funnel - # 15013  
#7 Locator Pin - # 13436  
(Requires Belted Magnum Powder System # 97126)

## .30-40 Krag - # 20185

#P Shellplate - # 13134  
#B Powder Funnel - # 13587  
#4 Locator Pin - # 14047

## .300 WSM, .300 RSAUM - # 20243

#B Shellplate - # 13347  
#.300 Short Mag Powder Funnel - # 18415  
#6 Locator Pin - # 15755  
(Requires XL Powder Die # 21253)  
(Requires Magnum Powder Bar # 21353)

## .30R Blaser - # 20270

#C Shellplate - # 13334  
#B Powder Funnel - # 13587  
#4 Locator Pin - # 14047

## .300 RUM - # 20239

#B Shellplate - # 13347  
#.30 Cal Long Mag Powder Funnel - # 15013  
#6 Locator Pin - # 15755  
(Requires Belted Magnum Powder System # 97126)

## 7.62x39mm - # 20213

#A Shellplate - # 13211  
#AK Rifle Powder Funnel - # 13015  
#2 Locator Pin - # 14062

## 7.62x54R - # 20346

#G Shellplate - # 13313  
#B Powder Funnel - # 13587  
#7 Locator Pin - # 13436

## .32-20 Winchester - # 20177

#O Shellplate - # 12013  
#S Pistol Powder Funnel - # 12845  
#3 Locator Pin - # 14060

## .303 British - # 20183

#4 Shellplate - # 13610  
#B Powder Funnel - # 13587  
#4 Locator Pin - # 14047

## 8x57mm Mauser - # 20201

#1 Shellplate - # 13692  
#M Powder Funnel - # 12963  
#1 Locator Pin - # 13930

## 8x57R - # 20201

#N Shellplate - # 10004  
#M Powder Funnel - # 12963  
#4 Locator Pin - # 14047

## 8x68mm - # 20272

#P Shellplate - # 13134  
#M Powder Funnel - # 12963  
#4 Locator Pin - # 14047

## 8mm Remington Magnum - # 20155

#B Shellplate - # 13347  
#M Powder Funnel - # 12963  
#4 Locator Pin - # 14047  
(Requires Magnum Powder Bar # 21353)

## .325 WSM - # 20891

#B Shellplate - # 13347  
#.325 WSM Powder Funnel - # 18948  
#6 Locator Pin - # 15755  
(Requires XL Powder Die # 21253)  
(Requires Magnum Powder Bar # 21353)

## .338 Winchester, .340 Weatherby - # 20156

#B Shellplate - # 13347  
#Q Powder Funnel - # 13406  
#4 Locator Pin - # 14047  
(Requires Magnum Powder Bar # 21353)

## .338 RUM - # 20258

#B Shellplate - # 13347  
#.338 Mag Rifle Powder Funnel - # 15012  
#7 Locator Pin - # 13436  
(Requires Belted Magnum Powder System # 97126)

## .338 Lapua - # 20257

#G Shellplate - # 13313  
#.338 Mag Rifle Powder Funnel - # 15012  
#6 Locator Pin - # 15755  
(Requires Belted Magnum Powder System # 97126)

## .348 Winchester - # 20217

#T Shellplate - # 12808  
#P Rifle Powder Funnel - # 13187  
#7 Locator Pin - # 13436

## .35 Remington - # 20166

#M Shellplate - # 13230  
#P Rifle Powder Funnel - # 13187  
#2 Locator Pin - # 14062

## .35 Winchester - # 20168

#P Shellplate - # 13134  
#P Rifle Powder Funnel - # 13187  
#4 Locator Pin - # 14047



# RL 450 & RL 550B Caliber Conversion Chart

Kits include shellplate, locator buttons and flow-thru powder funnel.

## .356 Winchester - # 20238

#L Shellplate - # 12703  
#P Rifle Powder Funnel - # 13187  
#1 Locator Pin - # 13930

## .35 Whelen/.358 Winchester - # 20170

#1 Shellplate - # 13692  
#P Rifle Powder Funnel - # 13187  
#1 Locator Pin - # 13930

## .38-55, .375 Winchester - # 20226

#7 Shellplate - # 12501  
#V Rifle Powder Funnel - # 13344  
#4 Locator Pin - # 14047

## .375 H&H, .375 Weatherby - # 20204

#B Shellplate - # 13347  
#R Rifle Powder Funnel - # 13531  
#4 Locator Pin - # 14047  
(Requires Magnum Powder Bar # 21353)

## .378 Weatherby - # 21665

#G Shellplate - # 13313  
#.378 Rifle Powder Funnel - # 15010  
#7 Locator Pin - # 13436  
(Requires Belted Magnum Powder System # 97126)

## .375 RUM - # 20261

#B Shellplate - # 13347  
#.378 Rifle Powder Funnel - # 15010  
#7 Locator Pin - # 13436  
(Requires Belted Magnum Powder System # 97126)

## 9.3x62mm - # 20273

#1 Shellplate - # 13692  
#R Rifle Powder Funnel - # 13531  
#1 Locator Pin - # 13930

## 9.3x64mm, 9.3x74R - # 20274

#P Shellplate - # 13134  
#R Rifle Powder Funnel - # 13531  
#4 Locator Pin - # 14047

## .38-40 Winchester - # 20178

#N Shellplate - # 10004  
#W Pistol Powder Funnel - # 13600  
#4 Locator Pin - # 14047

## .40-65 Winchester - # 20264

#G Shellplate - # 13313  
#.40 Cal Rifle Powder Funnel - # 11151  
#7 Locator Pin - # 13436

## .416 Weatherby - # 20262

#G Shellplate - # 13313  
#.416 Rifle Powder Funnel - # 10222  
#7 Locator Pin - # 13436  
(Requires Belted Magnum Powder System # 97126)

## .44-40 Winchester - # 20206

#N Shellplate - # 10004  
#.44-40 Pistol Powder Funnel - # 13600  
#4 Locator Pin - # 14047

## .444 Marlin - # 20164

#N Shellplate - # 10004  
#X Pistol Powder Funnel - # 12920  
#4 Locator Pin - # 14047

## .45-70 Government - # 20143

#G Shellplate - # 13313  
#T Pistol Powder Funnel - # 13407  
#7 Locator Pin - # 13436

## .458 Win Mag, .450 Marlin - # 20161

#B Shellplate - # 13347  
#T Pistol Powder Funnel - # 13407  
#4 Locator Pin - # 14047  
(Requires Magnum Powder Bar # 21353)

## .460 Weatherby - # 21664

#G Shellplate - # 13313  
#.460 Rifle Powder Funnel - # 15009  
#7 Locator Pin - # 13436  
(Requires Belted Magnum Powder System # 97126)

## .50 Beowulf - # 20467

#A Shellplate - # 13211  
#.50 Pistol Powder Funnel - # 14465  
#2 Locator Pin - # 14062  
(Requires Extra Large Powder Die # 21253)

# RL 450 & RL 550B Caliber Cross Reference Chart

## Shellplate 1 Locator Button 1

	Powder Funnel
.22 BR	A - #13426
.22-250	A - #13426
.30-06	B - #13587
.300 Savage	AK - #13015
.308 - 7.62 Nato	B - #13587
7.7 Japanese Arisaka	B - #13587
7.5 x 55 Swiss	B - #13587
7.65 Bel-Arg	B - #13587
.40 Super/.400 Corbon	W - #13600
.45 ACP	E - #13782
.240 Wby. Mag.	I - #13305
.243 Win.	I - #13305
6mm BR	6PPC - #13085
6mm Rem.- .244	I - #13305
.260 Rem./6.5x284	Y - #12870
.270 Win.	J - #13456
.284 Win.	J - #13456
7mm-08 Rem.	J - #13456
7x 57 Mauser	J - #13456
7 x 64 Brenneke	J - #13456
7mm Ex - 280 Rem.	J - #13456
.250 Savage-.250/3000	K - #13216
.25-06	K - #13216
.257 Ack. Imp	K - #13216
.257 Roberts	K - #13216
8mm Mauser	M - #12963
7mm BR	N - #13014
7mm Int'l	N - #13014
.358 Win.	P - #13187
.35 Whelen	P - #13187
6.5-06	Y - #12870
6.5 x 55 Swed Mauser	Y - #12870

## Shellplate 2 Locator Button 2

.256 Win. Mag.	543R - #13243
.22 Rem. Jet	A - #13426
.38 Sp.-.357 Mag./Max.	D - #13599
.38 LC	D - #13599

## Shellplate 3 Locator Button 3

.221 Rem. Fire Ball	A - #13426
.222 Rem. - Rem. Mag.	A - #13426
.223 - 5.56 mm	A - #13426
.380 ACP	F - #13806
6mm TCU	6PPC - #13085
7mm TCU	N - #13014
.17 Rem.	O - #12921
.30 Whisper	AK - #13015

## Shellplate 4 Locator Button 4

.303 British	B - #13587
.44 Sp. - Mag.	G - #13427
.44 Colt/.44 Russian	G - #13427

## Shellplate 5 Locator Button 2

9x25 Dillon/.357 Sig.	F - #13806
10mm/.40 S&W	W - #13600

## Shellplate 5 Locator Button 3

9x18	9 - #14980
.41 AE	AE - #13180
.30 Luger	C - #13564
.30 Mauser	C - #13564
9mm Luger	F - #13806
.38 Super	F - #13806

## Shellplate 6 Locator Button 1

	Powder Funnel
.41 Mag.	H - #13240
<b>Shellplate 7 Locator Button 4</b>	
.375 Super Mag.	543V - #13344
.38-55 Win. Ballard	543V - #13344
.219 Zipper	A - #13426
.219 Donaldson	A - #13426
.22 Savage Hi Power	A - #13426
.30 Herret	AK - #13015
.30-30 Win.	B - #13587
.32-40 Win.	B - #13587
.32 Win. Sp.	B - #13587
.357 Herrett	D - #13599
7-30 Waters	N - #13014
.25-35 Win.	K - #13216
7mm Int'l Rimmed	N - #13014

## Shellplate 8 Locator Button 8

.30 M1 Carbine	C - #13564
.32 ACP - 7.65mm	S - #12845
.32 Short Colt	S - #12845

## Shellplate 50 Locator Button 4

.50 AE	50AE - #14465
--------	---------------

## Shellplate A Locator Button 2

.22 PPC	A - #13426
.224 Wby. Mag.	A - #13426
6 PPC	6PPC - #13085
7.62 x 39 Russian	AK - #13015

## Shellplate B Locator Button 4

.458 Win. Mag.	543T - #13407
.375 H&H	544R - #13531
.375 Wby Mag.	544R - #13531
.416 Rem. Mag.	544RM - #13415
.450 Marlin/.470 Nitro	T - #13407
.300 Win. Mag.	B - #13587
.300 Win. Short	300 - #15013
.300 H&H Mag.	B - #13587
.300 Wby. Mag.	B - #13587
.30-338 Win. Mag.	B - #13587
.308 Norma Mag.	B - #13587
.270 Wby. Mag.	J - #13456
7mm Rem. Mag.	J - #13456
7mm STW	J - #13456
7mm Wby. Mag.	J - #13456
.257 Wby. Mag.	K - #13216
8mm Rem. Mag.	M - #12963
.350 Rem. Mag.	P - #13187
.358 Norma Mag.	P - #13187
.338 Win. Mag.	Q - #13406
.340 Wby. Mag.	Q - #13406
.264 Win. Mag.	Y - #12870
6.5mm Rem. Mag.	Y - #12870

## Shellplate B Locator Button 7

7 Ultra & WSM	7mm - #15019
.270 WSM	7mm - #15019
.300 Ultra	300 - #15013
.338 Ultra	338 - #15012
.375 Ultra Mag.	378 - #15010

## Shellplate C Locator Button 4

	Powder Funnel
.45 Colt/.45 Schofield	E - #13782
.454 Casull	E - #13782
.455 Webley	E - #13782

## Shellplate D Locator Button 3

.32 S&W Long	S - #12845
.32 H&R Mag.	S - #12845

## Shellplate E Locator Button 8

.22 Hornet - K Hornet	A - #13426
-----------------------	------------

## Shellplate G Locator Button 7

.45-70 Gov't	543T - #13407
.378 Wby. Mag.	544378 - #15010
7.62 x 54 Russian	B - #13587
.30-378/.300 Dakota	300 - #15013
.33 Win.	Q - #13406
.338 Lapua/.330 Dakota	338 - #15012
.40-65	RM - #13415
.416 Rigby & W'by	416 - #10222
.404 Jeff	416 - #10222
.460 Wby. Mag.	544460 - #15009
.480 Ruger/.475 Lineb'gh	E - #13782

## Shellplate H Locator Button 4

.45 Auto Rim	E - #13782
--------------	------------

## Shellplate L Locator Button 1

.220 Swift	L - #10831
.225 Win.	L - #10831
.30 Merrill	AK - #13015
.307 Win.	B - #13587
.45 Win. Mag.	E - #13782
7mm Merrill	N - #13014
.356 Win.	P - #13187
6.5 Japanese Arisaka	Y - #12870

## Shellplate M Locator Button 2

.35 Rem.	P - #13187
6.5 x 52 Carcano	Y - #12870
6.5 mm x 54 Mann-Scho	Y - #12870

## Shellplate N Locator Button 4

.444 Marlin	543X - #12920
.44-40 Win.	G - #13427
.38-40 Win.	W - #13600

## Shellplate O Locator Button 3

.25-20 Win.	543R - #13243
.218 Bee	A - #13426
.38 AMU	F - #13806
.32-20 Win.	S - #12845

## Shellplate P Locator Button 4

.30-40 Krag	B - #13587
.35 Win.	P - #13187
.376 Steyr	R - #13547

## Shellplate R Locator Button 2

.30 Rem. -32 Rem.	B - #13587
.25 Rem.	K - #13216

## Shellplate T Locator Button 7

.348 Win.	P - #13187
-----------	------------

## Shellplate U Locator Button 2

.38 S&W	F - #13806
---------	------------

## On the cover...

The RL 550B is pictured with optional accessories:

Strong Mount	#22051
Aluminum Roller Handle	#17950
Low Powder Sensor	#16306
Bullet Tray	#22214

Other accessories available for the RL 550B include:

Video Instruction Manual	#14621
Machine Cover	#13795
Maintenance Kit & Spare Parts Kit	#97016

The **Blue Press**, Dillon's monthly catalog, has a complete listing of accessories available for all machines.

---

## Dillon Precision Products, Inc.

8009 E. Dillon's Way  
Scottsdale, AZ 85260  
(480) 948-8009  
FAX (480) 998-2786

Web Site: [www.dillonprecision.com](http://www.dillonprecision.com)

Technical Support E-mail: [dillon@dillonprecision.com](mailto:dillon@dillonprecision.com)

See our Troubleshooting Section online at [www.dillonprecision.com](http://www.dillonprecision.com)

**Technical Support & Customer Service**

**(800) 223-4570**

